

# Coaxial Protectors - Quarter-Wave

## PRC2400



PRC2400-NW/MF

- **Surge Protective Device for Ultra High Frequency Transmissions**
- **Series Installed Quarter-Wave Technology**
- **Maintenance Free Design**
- **50kA Protection at 8/20µs**
- **Imp 10/350µs Withstand**
- **Low Insertion Loss**
- **VSWR < 1.2**
- **DC Block (Short-Circuit)**
- **UL497E Listed**

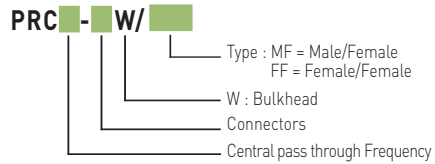

## Dimensions

(in mm)

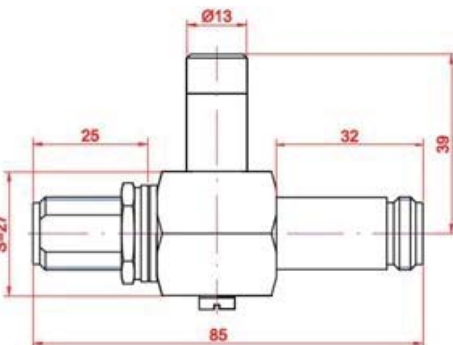
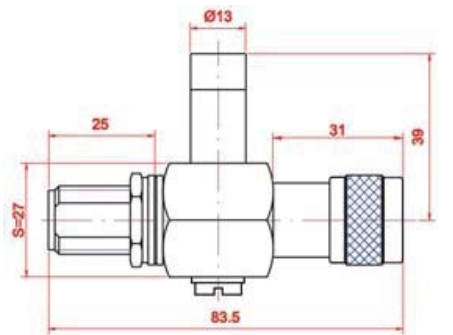

## Characteristics

CITEL Part Number	PRC2400-NW/FF	PRC2400-NW/MF
Maximum Power	1,500 W	1,500 W
Insertion Loss	< 0.15 dB	< 0.15 dB
I <sub>peak</sub> (8/20µs)	50 kA	50 kA
I <sub>imp</sub> (10/350µs)	20 kA	20 kA
VSWR (at all frequencies)	< 1.2	< 1.2
Impedance	50 Ohms	50 Ohms
Frequency Range	2.3-2.5 GHz	2.3-2.5 GHz
Mechanical		
Relative Humidity	0 to 100% Condensing	
Operating Temperature	-40°C to +85°C	
Operating Altitude	13,000 ft	
Connection	N-Type	
Earthing	M8 grounding lug	
Dimensions	See Drawing	
Standard Compliance	UL497E	

## Material

Component	Body	Male Contacts	Female Contacts
Housing Material	Brass	Bronze	Bronze